

FLUSH WALL PANEL

HIDDEN FASTENER METAL PANEL

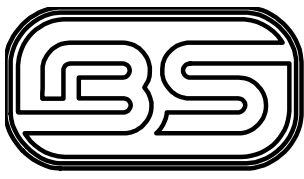

BRIDGERSTEEL

CREATE LASTING BEAUTY

Table of Contents

General Notes

Handling and Storage	1
Tools and Equipment, Field Cutting Panels	2
Safety	3
Fastener Notes	4
Panel Profiles	5
Flashing Profiles	5

Flashing Details

Vented Ridge Cap	14
Non-Vented Ridge Cap	15
Hip - Ridge	16
2 x 6 Top Cap	17
2 x 4 Top Cap	18
2 x 6 Gable	19
2 x 4 Gable	20
2 x 4 Eave	21
2 x 6 Eave	22
Style D Eave	23
Fascia Trim	24
F & J Style Trim / 1/2" J Trim	25
Endwall	26
Sidewall	27
Snow Break	28
Inside Corner	29
Outside Corner	30
Base Trim	31
Transition Low - High	32
Transition High - Low	33
28" W-Valley	34
Prow Gable	35
Overall Dormer	36
Dormer Tie-Ins	37

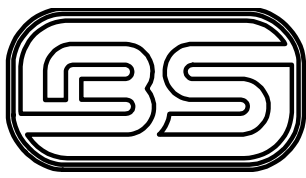

BRIDGERSTEEL
CREATE LASTING BEAUTY

**Congratulations on your Customized Metal Package
from Bridger Steel! We hope we have helped you
*Create Lasting Beauty***

When picking up or receiving your metal package check the parts you received against the invoice. If there are any discrepancies notify Bridger Steel Personnel right away.

Handling

Handle your panels and trim with care to avoid damage. Longer panels may need more than one pickup point when lifting on or off a trailer. Trim bundles can be heavy and awkward. Don't lift more than you can safely handle. Break open the bundle if needed.

Storage

Bridger Steel recommends you should have your structure built before ordering metal. With actual building measurements, your materials can then be ordered. Because of our quick turnaround time you will have the material in a matter of one to three days. The longer the metal package is stored at your work site, the more opportunity for damage to occur.

If for some reason you cannot install the metal right away, proper storage is a must. Store metal panels and other materials in a covered, dry, well ventilated area ensuring moisture and direct sunlight are kept away from panels. If stored outside, wrap a tarp loosely around the panel bundles so air can circulate freely to avoid moisture build-up. One end of the bundle should be elevated so any accumulated moisture can run off. Never store materials in direct contact with the ground. The trim package you receive has a protective plastic film on it. The film should be removed within 90 days.

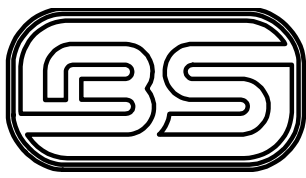

Tools and Equipment

- Screw Gun
- Tin Snips
- Tape Measure
- Pop Rivet Tool
- Chalk Line
- Hemming Tool
- Locking Pliers
- Nibbler
- Circular Saw*

****When using a circular saw to cut metal panels, always cut from the back side of the metal panel to keep the metal shavings from marring the paint. Always wear hearing and eye protection when using saws to cut metal.***

Field Cutting panels

Tin snips or nibblers are recommended for cutting metal panels and trim. All cut metal shavings should be removed from the panel to prevent damage to the finish. One way to prevent shavings on the finish side of the panel is to cut from the primer side of the panel. Never cut panels on top of existing panels. Always wear gloves and eye protection when cutting metal panels. If using a circular saw always wear hearing protection! All installed products should be wiped free of any debris at the end of each workday.

CAUTION! Clean all metal shavings and particles off of roof to avoid unsightly rust stains.

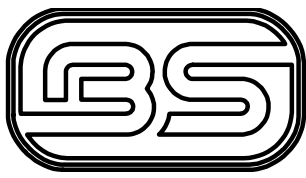

Safety

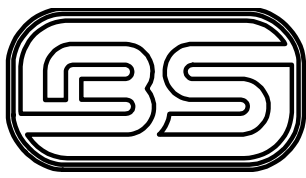

Safety is always your first consideration when installing your metal package. Hazards exist on the ground as well as on the roof.

- Always be aware of where you are on the roof. Openings, edges, electrical lines and tripping hazards (cords and equipment) are a constant danger.
- Watch electrical lines when maneuvering panels.
- Never install metal roofing on windy or stormy days. The wind can get under the panel and force you off the roof. Once the panel is loose and airborne it can become a sharp projectile.
- Roofing can be very slick when dusty, wet, or covered with frost. Avoid being on the roof when these conditions are present.
- Never step on panels until they are in place and secured with fasteners. Then only step in the flat areas and not on the panel ribs.
- Wearing soft soled shoes will help with traction while preventing scratching the panels.
- Use fall protection where needed.
- Be aware of your coworker. Make sure they are not putting themselves in danger.
- If your building has an open purlin system make sure to walk on the purlin not in between the purlin this may result in injury.



Fastener Installation

Screw fasteners have been proven to have 2 to 3 times the holding power of nails. For maximum holding power, it is recommended that the minimum wood penetration be 1 inch. Utilizing screw fasteners with neoprene and metal washers have an excellent quality and are specifically designed for fastening metal roofing panels. Screw fasteners can be used on the panels' high rib, particularly for side lap attachment. For OSB and plywood 1/2" or less, use #14 x 1-1/2" wood screws.

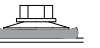
FASTENERS		
CORRECT	TOO LOOSE	TOO TIGHT
 <p>EPDM MATERIAL IS COMPRESSED AND VISIBLE AT WASHER. FASTENER IS PROPERLY INSTALLED.</p>	 <p>EPDM NOT AT VISIBLE JOINT. NOT ENOUGH COMPRESSION TO MAKE A SEAL.</p>	 <p>FASTENER IS OVER-DRIVEN AND EPDM IS PROTRUDING BEYOND EDGE OF FASTENER.</p>

To prevent damage to panels and trim, install immediately or store in a cool dry area. Carbonized Steel, Galvanized Steel, Aluminized Steel, Galvalume and all alloys of Aluminum are susceptible to what is commonly referred to as "White" or "Black" rust and water stain. These are caused by electrolysis, which occurs when moisture exists between stacked sheets. Painted metal products are also susceptible to a change of or loss of paint gloss discoloration, delaminating, disintegrating, and other accelerated defects of the paint as a result of moisture between the panels sheets. Bridger Steel assumes no responsibility of liability for damage to our product which occurs in the possession of the consignee or which we deem to be improper handling and storage. If panels are to be cut or drilled be certain to wipe free any metal filings that may accumulate. Protective plastic film on the trim should be removed within 90 days. Failure to follow these instructions may void the warranty.

- Are the fasteners installed correctly? Sometimes fasteners are tightened down too much which may cause them to cut or split the neoprene washers.
- Other fasteners may not be tightened properly which will not create a seal between the fastener and the metal panel or flashing.
- Neoprene washers may break down over time due to expansion and contracting of the metal panels or from exposure to ultraviolet rays. By rubbing your finger nail over the washer you will notice if it is still flexible or has hardened and is breaking apart.

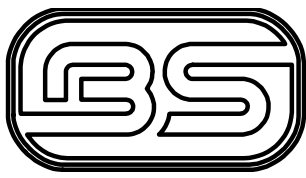

All roofs, metal or shingle, require periodic maintenance. Obviously, an expert should perform any complex repair or addition; however, there are certain items that an owner can perform in order to maintain his or her roof in excellent condition.

PERSONAL SAFETY

Safety is the top priority, climbing ladders and walking on any roof can be dangerous. Always use some method of fall protection that is approved by OSHA. Failure to provide the required safety equipment can result in serious injury or death.

During the inspection, remember to take the following precautions:

- Use fall protection and all required safety equipment.
- Keep foot traffic to a minimum.
- Never walk on eave or rake flashings, gutters, hip, or ridge flashings.
- Never walk on any skylight or fiberglass type panels.
- Always walk in the flat area of the panel and near the roof panel supports.
- Don't wear black soled shoes; the marks they leave are almost impossible to remove.
- Soft soled shoes are recommended.



FLUSH SOFFIT PANEL

CORNERS

INSIDE CORNER

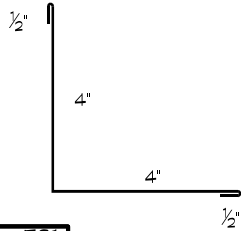

Profile Code: **FS1**
Detail Code: **OG**
Detail Num: **C**
Girth Num: **9.0"**

OUTSIDE CORNER

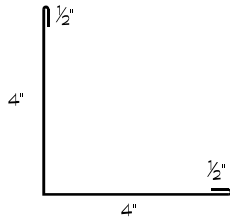

Profile Code: **FS1**
Detail Code: **OG**
Detail Num: **OC**
Girth Num: **9.0"**

OUTSIDE CORNER

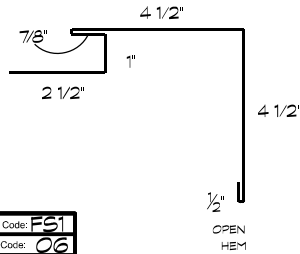

Profile Code: **FS1**
Detail Code: **OG**
Detail Num: **OC**
Girth Num: **13.875"**

INSIDE CORNER

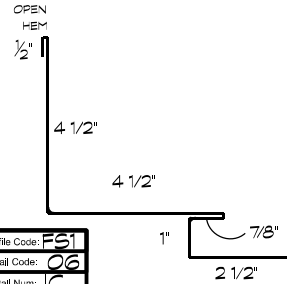

Profile Code: **FS1**
Detail Code: **OG**
Detail Num: **C**
Girth Num: **13.875"**

TRIM PIECES

FASCIA

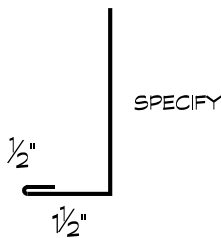

Profile Code: **FS1**
Detail Code: **OG**
Detail Num: **F**
Girth Num: **VAR.**

Z-METAL

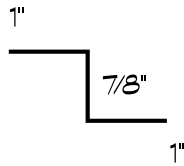

Profile Code: **FS1**
Detail Code: **OG**
Detail Num: **ZM**
Girth Num: **2.875"**

REVERSE J-METAL

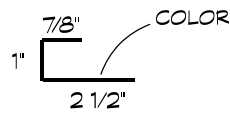

Profile Code: **FS1**
Detail Code: **OG**
Detail Num: **RJM**
Girth Num: **4.375"**

H-METAL

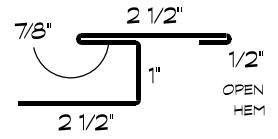

Profile Code: **FS1**
Detail Code: **OG**
Detail Num: **HM**
Girth Num: **7.375"**

F & J TRIM

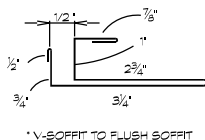

* V-SOFFIT TO FLUSH SOFFIT

Profile Code: **FS1**
Detail Code: **O5**
Detail Num: **FJ**
Girth Num: **9.625"**

1" DOUBLE J TRIM

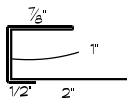

Profile Code: **FS1**
Detail Code: **O5**
Detail Num: **JM**
Girth Num: **6.25"**

WAINSCOT

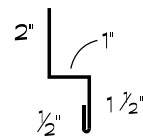

Profile Code: **FS1**
Detail Code: **O5**
Detail Num: **ZM**
Girth Num: **5.0"**

1" J-METAL

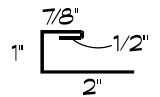

Profile Code: **FS1**
Detail Code: **O5**
Detail Num: **JM**
Girth Num: **4.375"**

HEAD TRIM

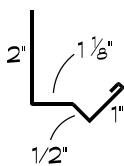

Profile Code: **FS1**
Detail Code: **O5**
Detail Num: **HT**
Girth Num: **5.125"**

BROOM BASE

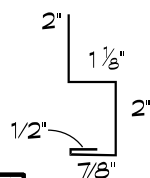

Profile Code: **FS1**
Detail Code: **O5**
Detail Num: **BT3**
Girth Num: **6.5"**

DOUBLE BASE DRIP

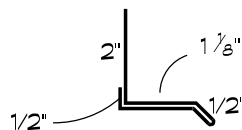

Profile Code: **FS1**
Detail Code: **O5**
Detail Num: **BT2**
Girth Num: **5.75"**

BASE DRIP

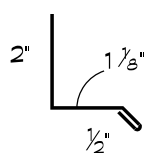

Profile Code: **FS1**
Detail Code: **O5**
Detail Num: **BT1**
Girth Num: **4.125"**

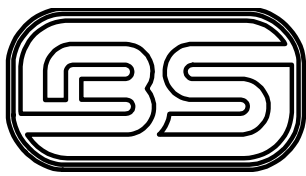

BRIDGER STEEL

CREATE LASTING BEAUTY

INSTALLATION NOTES

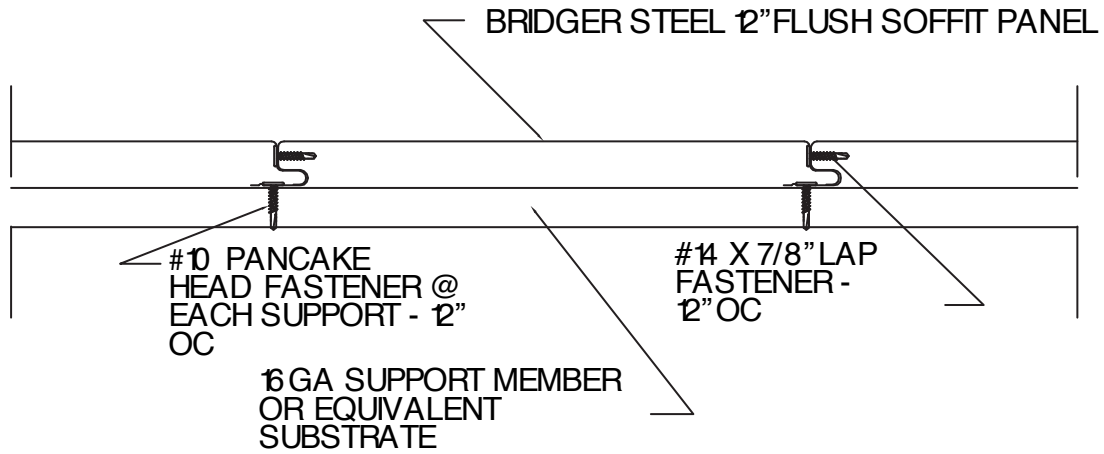

ATTACHMENT DETAIL

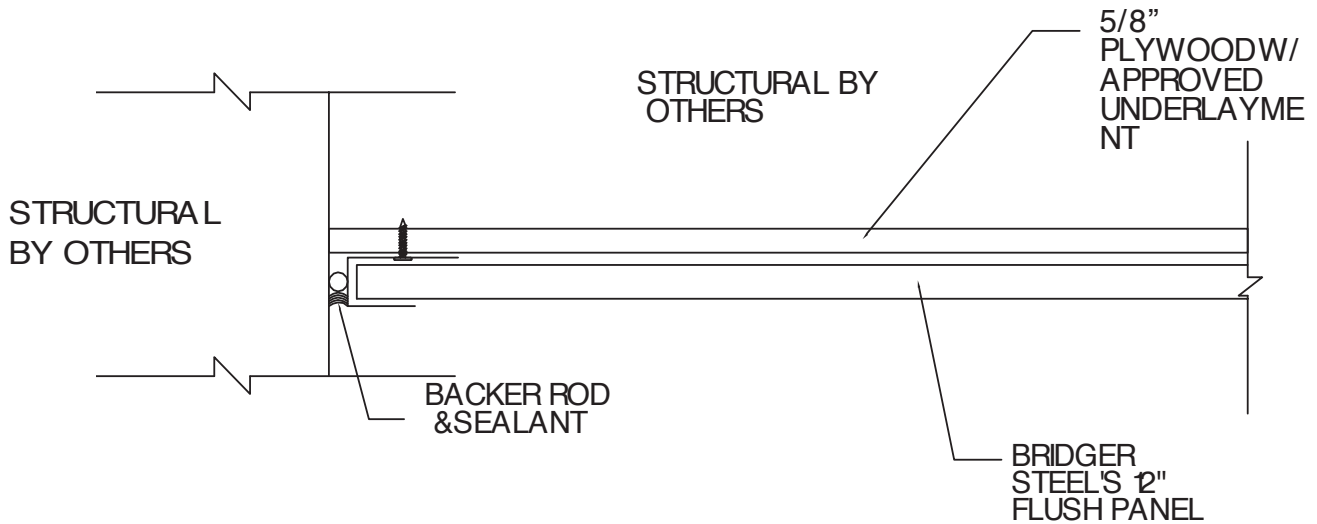

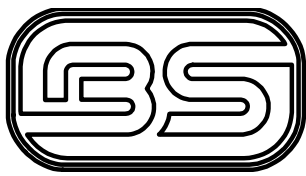

BRIDGERSTEEL

CREATE LASTING BEAUTY

INSTALLATION NOTES

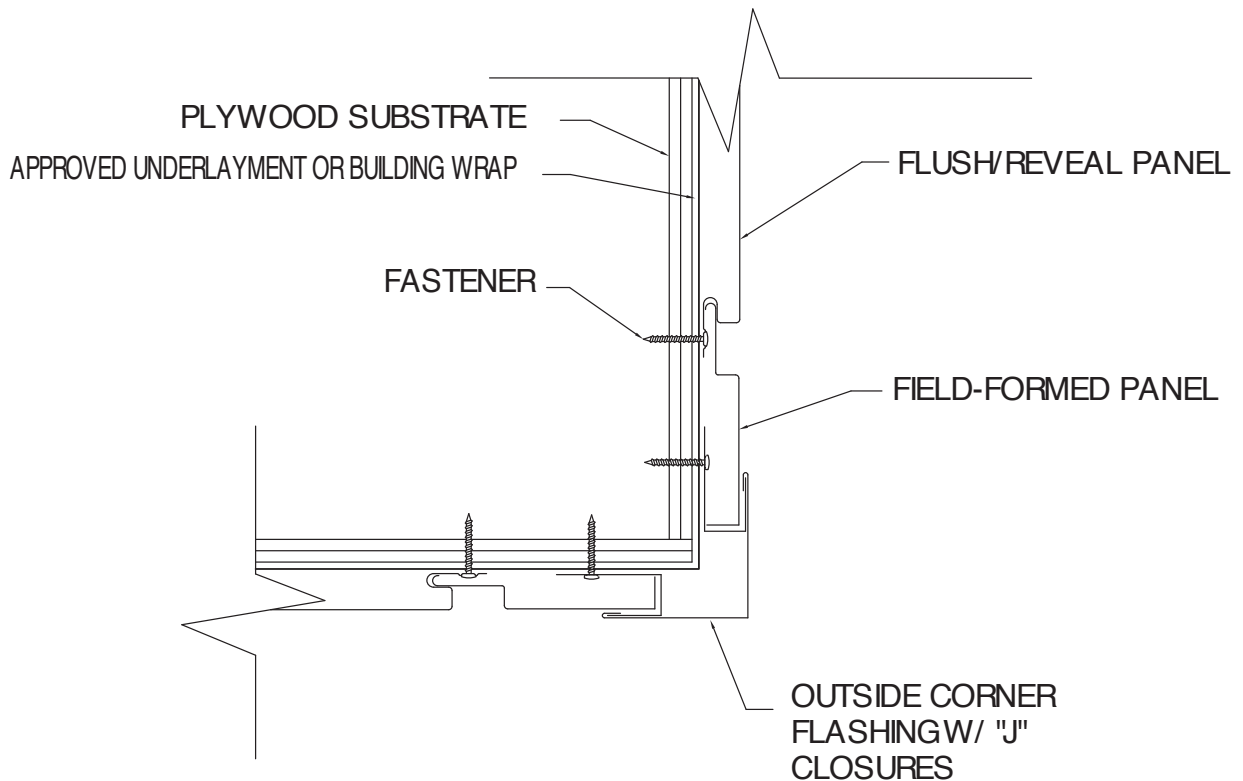
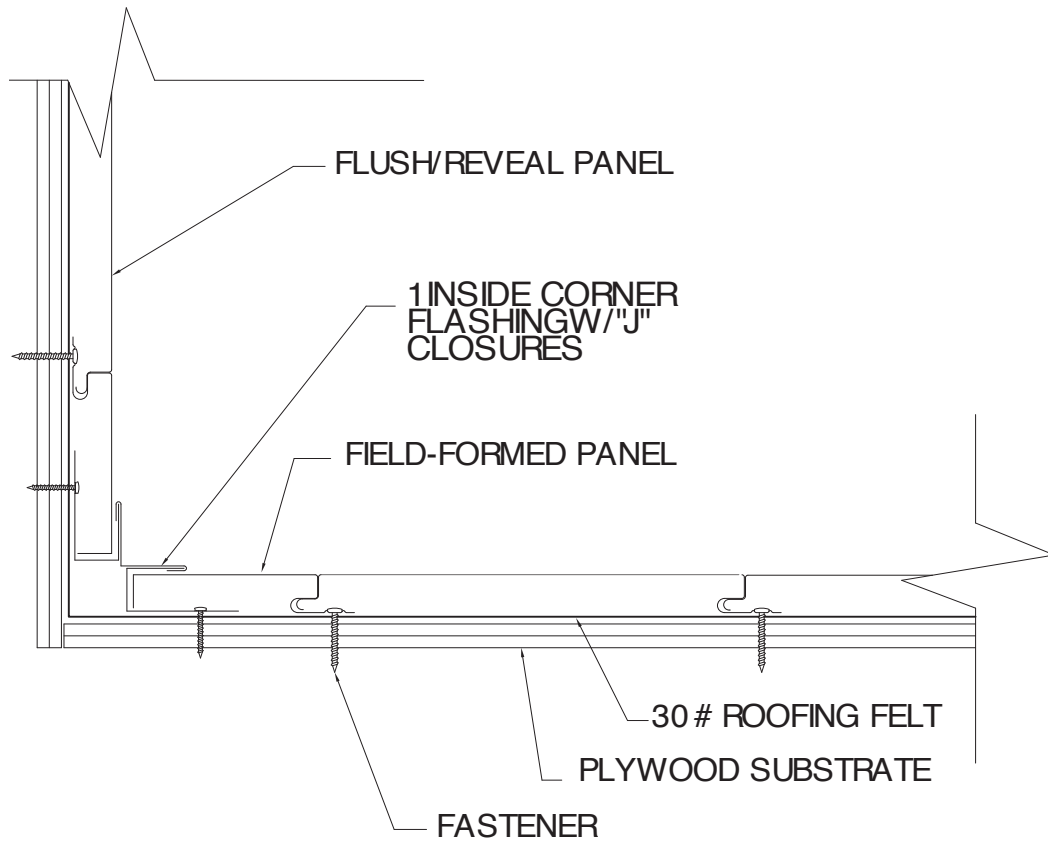

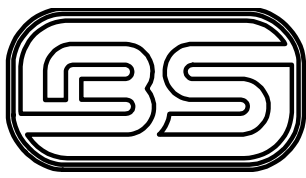

BRIDGERSTEEL

CREATE LASTING BEAUTY

INSTALLATION NOTES

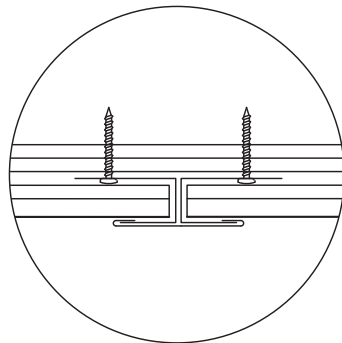
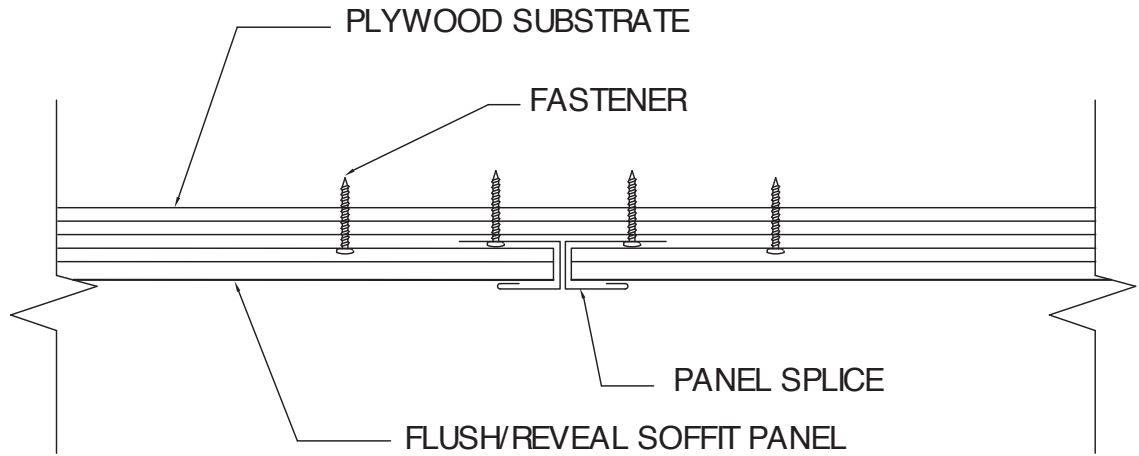

ALTERNATE METHOD

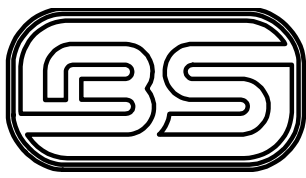

BRIDGERSTEEL

CREATE LASTING BEAUTY

